

Sink Foster Milano

Kitchen Sinks

Code: 1013 850



DETAILS

Edge/Installation Type	Undermount
Finish	Foster brushed
Material	AISI 304 stainless steel
Texture	Brushed in line
Base	60 cm
Dimensions	510x500 mm
Standard fittings	Fixing hooks, gasket, drain, overflow and siphon, boxed packing
Mixer holes	No standard holes
Built-in hole	462x452 mm

Drainer No

Width 51 cm

Bowl dimension 462x400mm

Number of bowls 1 bowl

Waste fitting 3,5" drain

FEATURES

Diamond-shape bottom The draining of water is an important feature in a sink, and it's always taken good care of in Foster products. In the bent-welded sinks, which would have a flat bottom, the proper draining is guaranteed by the elegant beveling, which helps the water flow.

High thickness 1mm thick steel. A significant thickness, which guarantees the maximum sturdiness and durability.

Space waste fitting The elegant SPACE steel cap closes the drain and leaves no visible residues collected in the basket below. Space also has a small footprint and allows the optimal use of the under-sink compartment.

Save space system Drain and siphon are designed to leave as much space as possible in the under-sink area, more and more useful today for theseparate waste collection systems.

Triple recess - sliding accessories The Foster Milano sink has an ingenious design that makes it simple to use a large set of optional accessories. On the topmost supporting step, the innovative Black grids slide, creating a large and practical surface to rinse food and crockery. The second step is meant to support and allow the sliding of a complete combination of accessories, which make some operations practical and safe: rinse, drain, slice, grate... everything can be done inside the sink. The third supporting step is on the bottom of the bowl. On this step one can rest the Black grids, making it possible to rinse foodstuffs without their coming in contact with the bottom of the sink, which may be dirty.

Perimetral overflow The overflow is always a security on the Foster sinks that prevents the overflow of water in case of oversights. The perimeter drain solution improves aesthetics thanks to its square and essential shape.

TECHNICAL DATA

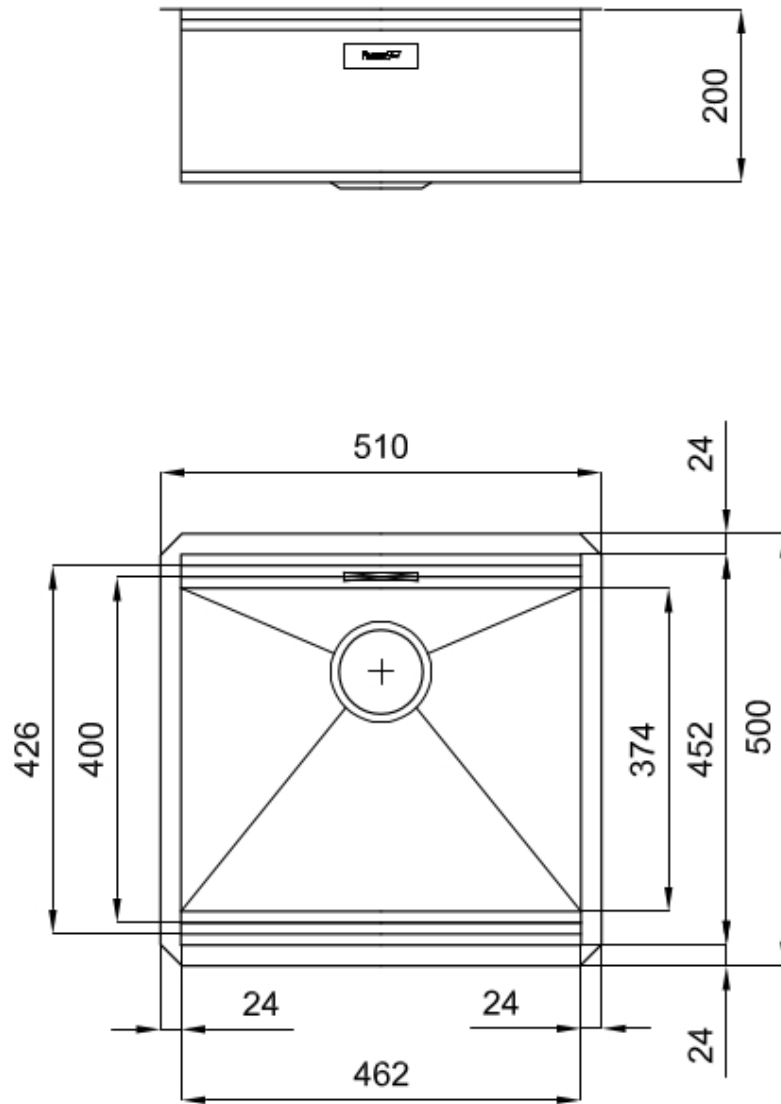

Milano Optional accessories / Accessori opzionali

The "rails" system makes it possible to use a combination of numerous accessories. Grids, chopping boards, utensils' ranging system, bowls and containers of different dimensions can be alternated in the workspace with a simple gesture, and can easily be stacked, in order to be on hand at all times.

Il sistema di "corsie" rende possibile l'utilizzo combinato di innumerevoli accessori. Griglie, taglieri, portautensili, vaschette e contenitori di varie dimensioni si alternano nella zona di lavoro con un semplice gesto e possono essere impilati, sempre a portata di mano.

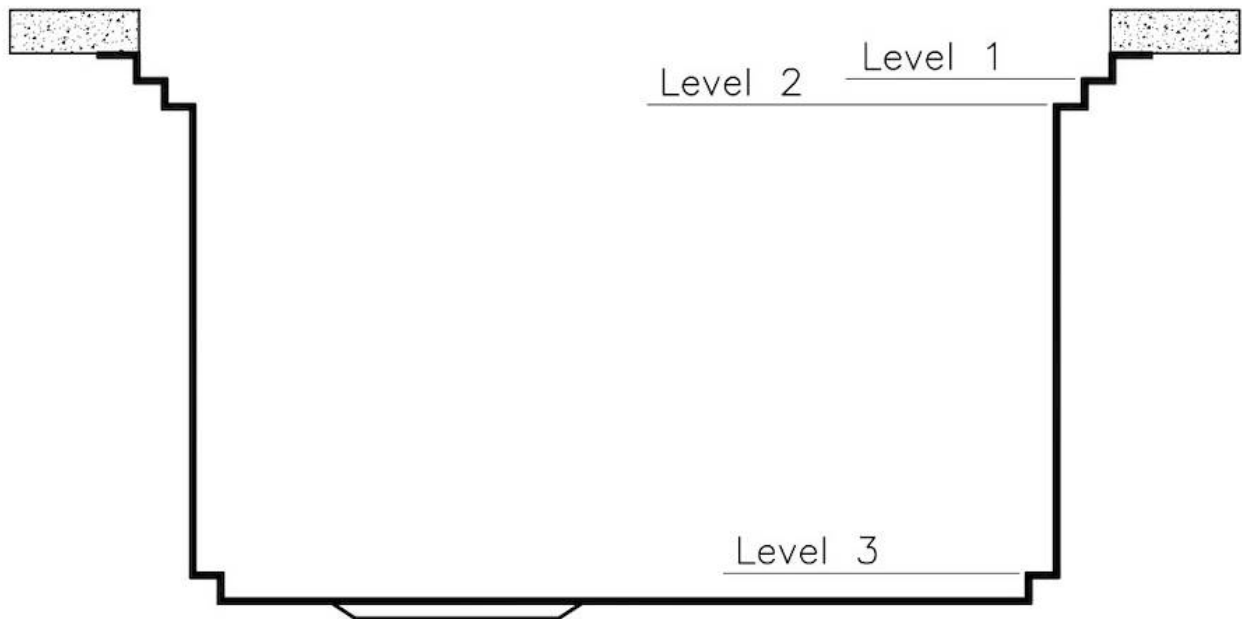

Milano Level 1

Compatible accessories/Accessori compatibili:

8100 600
8642 000



Milano Level 2

Compatible accessories/Accessori compatibili:

8153	100
8631	300
8644	101



Milano Level 3

Compatible accessories/Accessori compatibili:

8100 600



GALLERY



OPTIONAL ACCESSORIES



Black grid
8100 600



Glass chopping board
8631 300



HPDE Twin chopping board
8644 101

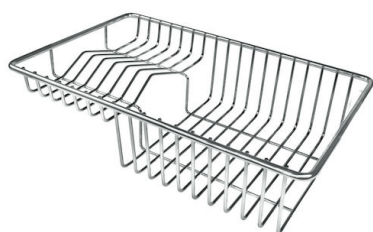

Stainless steel plate rack
8100 303

* only in combination with the accessory
8644 101



Walnut-wood chopping board
8642 000



**Graters kit with ring-holder and
food collection tray**

8159 101
* only in combination with the accessory
8644 101



Stainless steel perforated tray
8151 000

* only in combination with the accessory
8644 101

RECOMMENDED PAIRINGS



Cooker hob Foster Milano
7637 000



Mixer Tap FL
8521 000

OPTIONAL AUTOMATIC WASTE FITTINGS



Automatic waste fitting
8407 113



Space automatic waste fitting
8407 108



Space automatic waste fitting
8407 109



Space Light automatic waste fitting
8407 117



Space Milano automatic waste fitting
8407 115



Space Push automatic waste fitting
8407 116